

Large-width Power Harrows

1040 R SERIES



[www.kuhn.com](http://www.kuhn.com)



be strong, be **KUHN**



HR 1040 R

# CONTROL THE POWER!

## HIGH OUTPUT NEEDED, BUT LIMITED TIME AVAILABLE

Due to larger farm sizes, it has become a real brain-teaser for arable farms as well as contractors to synchronise optimum weather windows, high work productivity and work quality. Drivers have to respect tight schedules during the season. In this context it is clear that seedbed preparation tools have to achieve high outputs while running smoothly and continuously as long as they are needed.

The new KUHN foldable HR 1040 R power harrow series meets these requirements with large working widths from 5.96 to 8.05m, as well as constant monitoring of the gearboxes with the KTS 20 unit.

## WORK OUTPUT IS ALSO A QUESTION OF RELIABILITY

It's worth taking a closer look inside the power harrows to ascertain their high manufacturing level. You will benefit from the soundly designed rotor drive as well as the rigid gearcase, which ensure extra-long service life with reduced maintenance time and costs.

### KUHN's HR 1040 R foldable power harrows in brief:

	Working width (m)	Max. tractor power (kW/hp)	KTS 20 monitoring unit
<b>HR 6040 R</b>	5.96	336 / 460	as standard
<b>HR 7040 R</b>	6.96	345 / 480	as standard
<b>HR 8040 R</b>	8.05	365 / 500	as standard

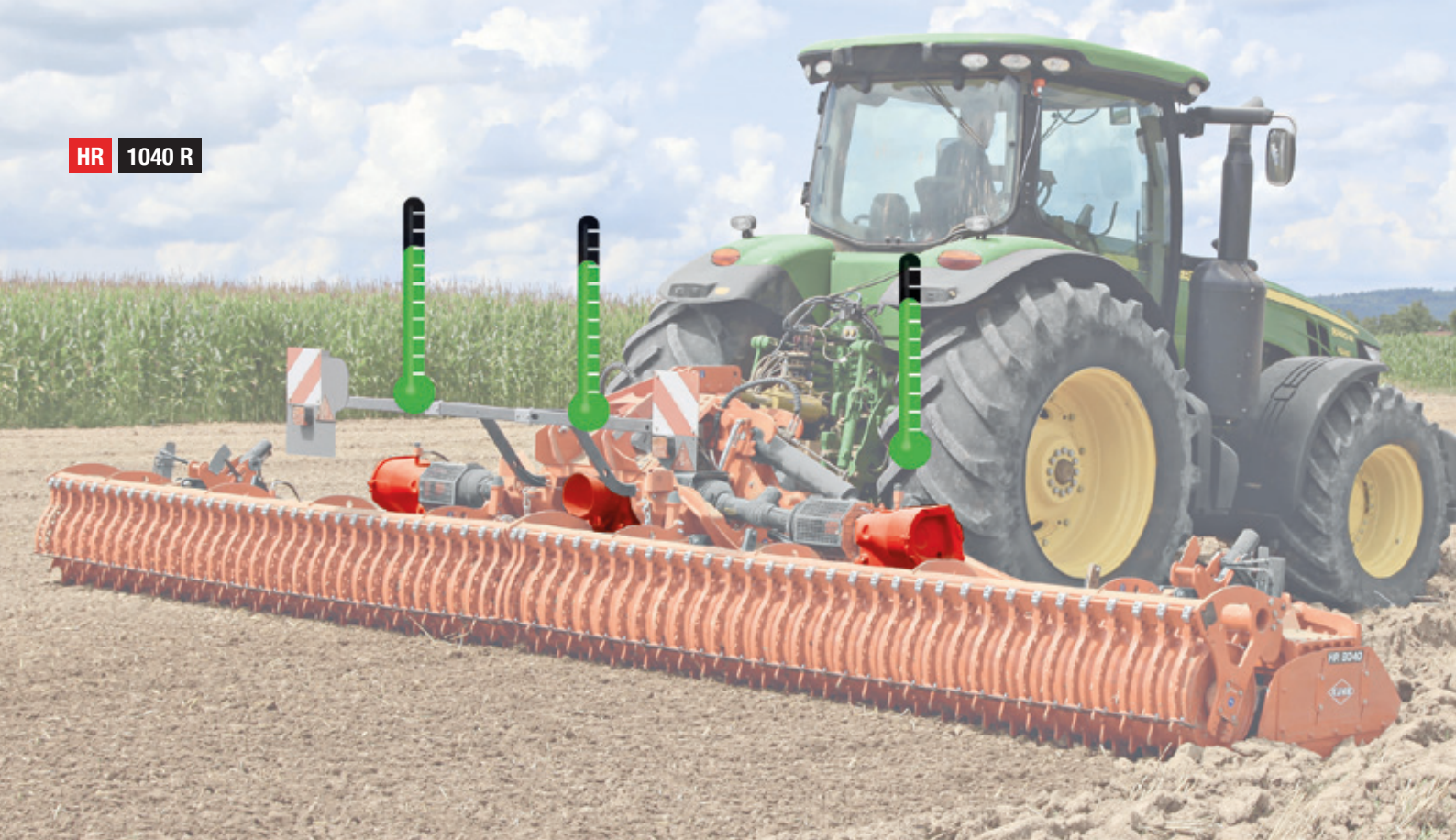

## KTS 20: THE ASSURANCE OF A RESPECTED SCHEDULE



In order to help the driver keep his schedule and peace of mind, the foldable HR 1040 R power harrows are equipped as standard with the KTS 20 monitoring unit. Installed in the cabin, it continuously monitors the temperature and rotation of the machine's three gearboxes. As soon as a torque limiter or oil temperature device is activated, the driver can react quickly and thus ensure a continuous work.

This can save roughly 900€ per day: the loss if the power harrow is stopped one day during peak season.



**PATRICK OLIVIER, farmer and contractor**

Ambacourt, Lorraine region, France.  
Farm with 400ha and 1,000 feeder cattle.  
Contracting business with 7 permanent and 10 seasonal employees.

Patrick Olivier has been convinced by his power harrow from the first moment on:  
"The HR 8040 R really suits me very well. I think that the in-cab control box monitoring the oil temperature is very useful. This way, in case of problem, you are alerted and you can stop to check what is happening."



# LARGE WIDTHS CALL FOR HIGH HORSE POWERS

The HR 1040 R foldable power harrows are adapted for intensive use with high-power tractors. You have the possibility to harness a tractor of up to 460, 480, and 500hp in front of HR 6040 R, HR 7040 R, and HR 8040 R, respectively. Several drive train features make these models ready for work in virtually all conditions on big farms aiming for large outputs during seedbed preparation.

## THE PERFECT MATCH WITH BIG TRACTORS:

- The central gearbox (1) is equipped with an oil cooler with integrated pump. The synthetic oil used works at higher temperatures than standard oils.
- HR 1040 R power harrows are adapted for cat. 3, 4, and 4N linkages (2). They can also be coupled to Quick Hitches, cat. 4.
- The primary PTO shaft is reinforced.
- 2 cam cut-out clutches (1 on each side gearbox).
- The central gearbox is offset rearwards to increase the PTO shaft length and reduce shaft angles. This is useful for tractors with large-diameter wheels.

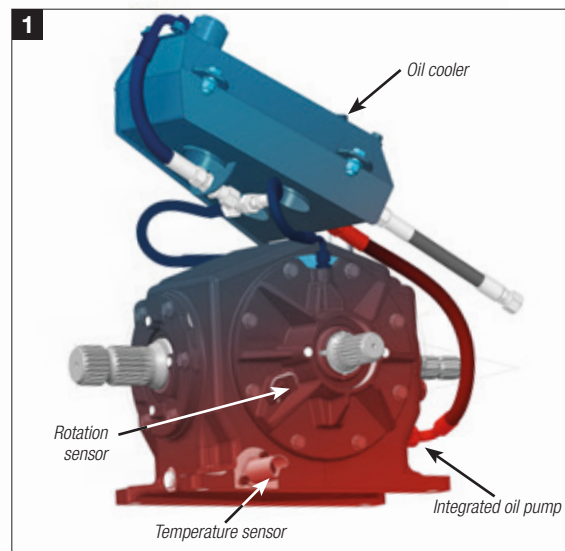

“The machine is coupled to a tractor with 300hp PTO. The machine is easily pulled whether uphill or downhill. It is always drawn between 4 and 8kph depending on the type of soil.”

“I have owned several KUHN power harrows and everytime I was satisfied. They operated for 6 to 8 seasons.”



Scan this QR-code with your Smartphone to discover the entire interview.



# ROBUST, RESISTANT, RELIABLE... SIMPLY A KUHN ROTOR!

The strong rotor drive train is fully protected by a rigid gearcase. Let's look a bit closer into the heart of the new large-width KUHN power harrows:

**1. Maintenance-free highly rigid trough:** 8mm thick trough made from fine grain high-tensile steel. It contains semi-liquid grease, which ensures lifelong lubrication of pinions and gearwheels. O-rings and lip joints ensure sealing for a longer service life.

**2. No gearwheel overhang:** Convex treated and forged steel gearwheels so that the drive forces **(A)** are transmitted at the centre of the upper roller bearing (over-dimensioned) without creating an overhang. High capacity shaft guidance and torque transmission capability thanks to the important spline length in contact with the shaft **(B)**.

**3. No maintenance on bearings:** Large dimension conical roller bearings are always perfectly aligned in a one-piece cast housing not subject to distortion. Factory preloaded with a calibrated spacer **(C)** for increased distance between bearings, no further adjustments are required.

**4. Perfect bearing hold and gearcase protection:** The 28mm thick cast iron housings ensure perfect bearing and trough protection against wear and distortion.

**5. Reinforced sealing:** A cassette seal provides very efficient protection against bearing pollution.

**6. No play on the spline level:** Rotor shafts with rolled splines are obtained by metal compression (no milling). Perfect connection with the shaft thanks to the conical centring of the blade holders (KUHN patent), preventing play on the spline level.

**7. Round and flat blade holders:** shape for smoother operations with less lateral soil pushing, resulting in less power consumption.

**8. FAST-FIT blades as standard:** long, straight blades (18mm thick, 335mm long) with quick-release system ensure high quality work at low power requirement.

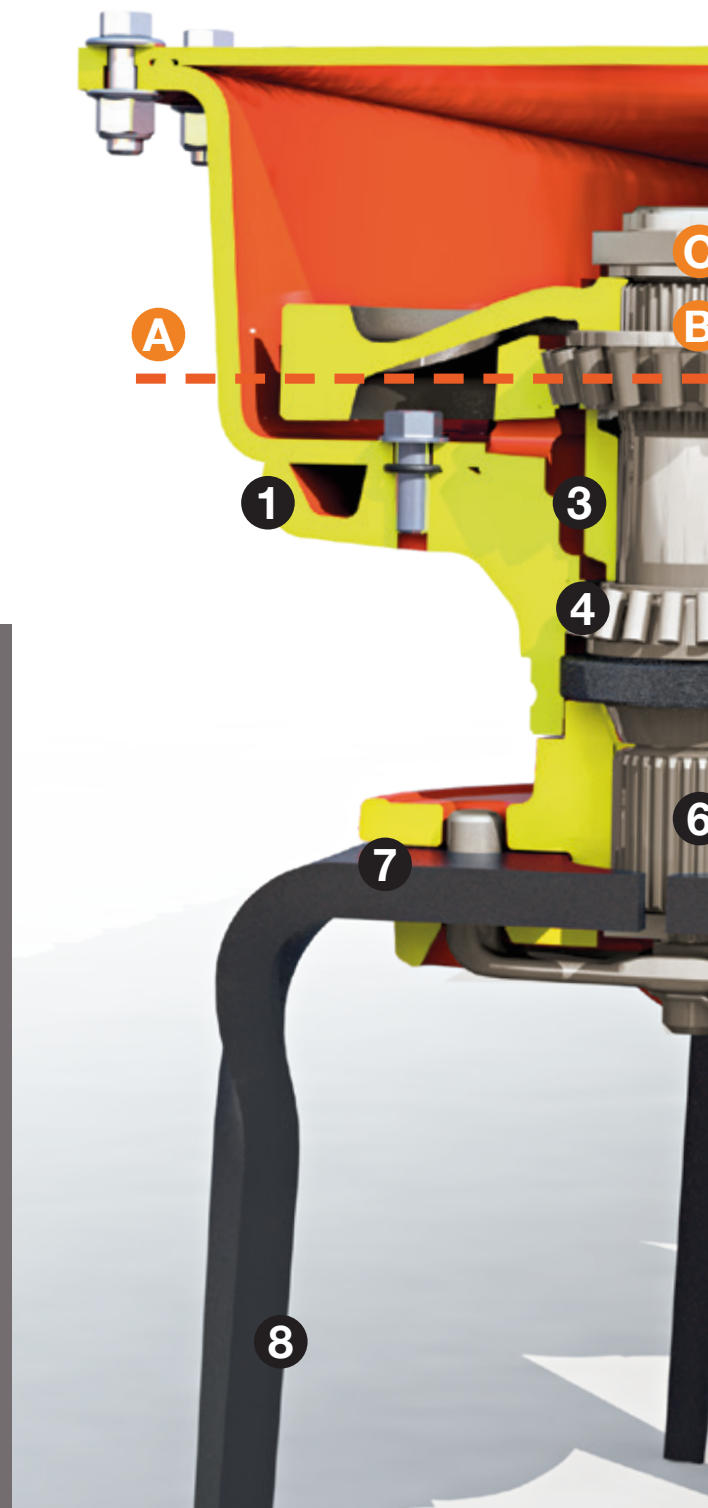

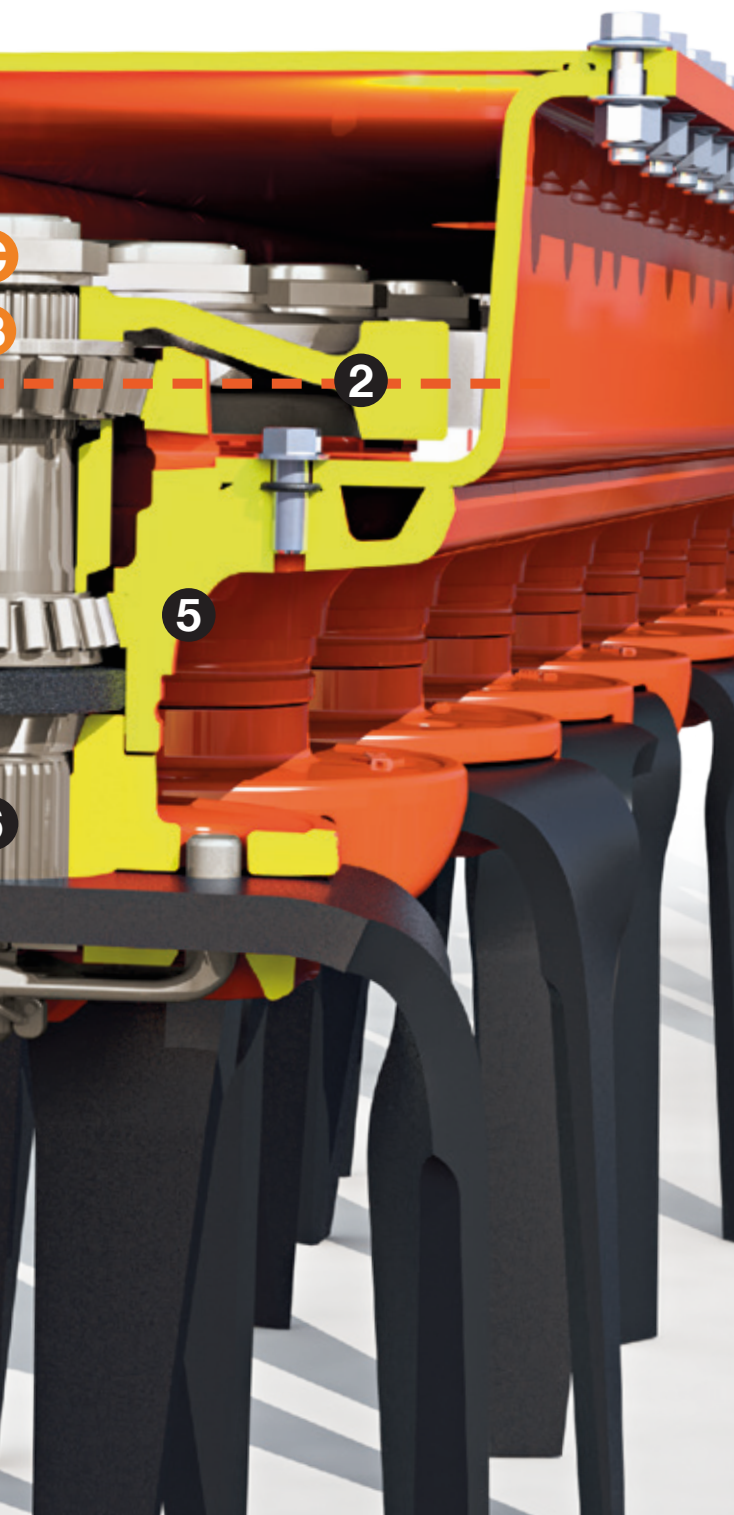

## BLADES THAT OFFER MORE POSSIBILITIES

With seedbed preparation you pursue three major goals to get your cultivations off to a good start:

- small clods on top, fine soil around the seed,
- in-depth packing,
- exact levelling to ensure even germination.



### FAST-FIT DURAKUHN BLADES AS STANDARD

The KUHN HR 1040 R power harrows are supplied as standard with tungsten carbide-coated blades for long life. These DURAKUHN blades are made to last.



### WORKING PARTS DESIGNED FOR LESS POWER REQUIREMENT

The combination of specifically designed blades, blade holders and the special geometry of the FAST-FIT quick-release system, limit blade holders from penetrating the soil while reducing the lateral soil pressure to which the twisted blades are exposed. The rounded shape of the blade holders as well as the large spacing between the latter and the casing facilitates soil flow inside the machine when working at deep depth.

The FAST-FIT fixation has been redesigned and is now better integrated in order to optimize the soil flow inside the machine.

# PERFECTING SEEDBED PREPARATION

Optimum seedbed preparation is an imperative prerequisite for good and homogeneous germination and crop development as well as vigorous young plants. Being able to adapt the crumbling, levelling and packing work of the harrows easily to the prevailing conditions is the key to maximize the productivity of your crops.

## PERFECTLY ADAPTABLE TO HETEROGENEOUS CONDITIONS

Soils may vary much within one plot. Simple, real-time, and continuous adjustments are thus important to achieve superior work quality results in such changing conditions. On the HR 1040 R series power harrows both working depth and levelling bar position can be adjusted hydraulically from the cabin, both using a master/slave system. Indicators are positioned in such a way that they are easy to check from the cabin.



## PERFECT FINISH WITH THE HYDRAULICALLY ADJUSTED LEVELLING BAR

You can set the levelling bar angle into three different positions. This provides for precise tuning of the soil crumbling: close to the rotors for a fine soil preparation in very heavy conditions or tilted to the back for light seedbed preparation. It also improves the power consumption management. An additional comfort feature: The levelling bar is fitted to the roller frame in order to avoid its readjustment when changing the working depth.

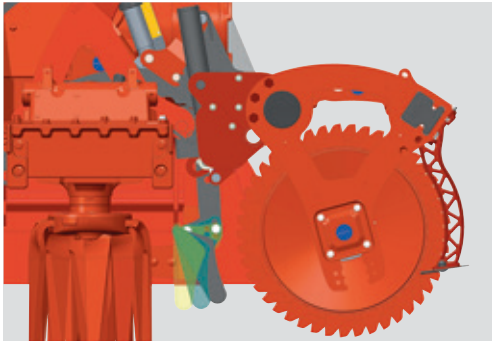

## TWO MACHINE HALVES. ONE WORK QUALITY

You have the possibility to work in rigid or floating position. In the latter configuration both halves can move up and down individually between +/- 2.5° in order to better adapt to the surface profile. A long side deflector, adjustable in height, ensures a perfect finish between the passes. The lower part is easily replaced once worn down.



## A PERFECT SOIL SURFACE LEVELLING

The HR 1040 R series power harrows have been designed in a way that the two machine halves are as closely positioned to each other as possible. In this way unworked ridges between them are avoided. The standard front share in front of the gap adds to an impeccable work across the entire working width.

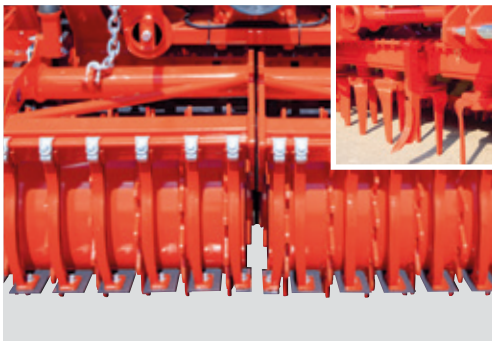





### KEY FEATURES FOR FINE TILTH CONDENSED:

- Specific straight blade shape.
- Longer blades that ensure a high work quality down to depth of 20cm.
- Duplex side gearboxes: adapt the rotors' speed (up to 507min<sup>-1</sup>) to the soil conditions.
- Levelling bar angle and height.
- Track eradicators as option.
- Front share between machine halves as standard.



## A LARGE CHOICE OF ROLLERS TO MEET YOUR NEEDS



1

### 1) STEELLINER:

This furrow roller is very appreciated by users also in solo use. With 550mm diameter it provides a very good rotation and carrying capacity. The roller leaves behind consolidation in strips, promoting water absorption and soil respiration. It creates a rough surface with a high share of fine soil behind, thus reducing the risk of capping. This is true for dry, hard ground as well as in more difficult and wet conditions.



2

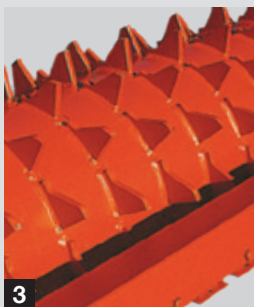

3

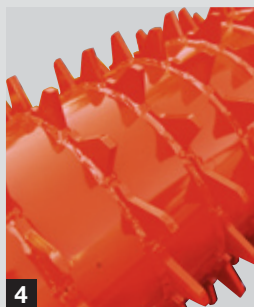

4

### 2) MAXICRUMBLER:

light tube roller (520mm) for dry, non-sticky conditions.

### 3) MAXIPACKER:

allrounder tooth packer roller (535mm) for tamped soil underneath and loosened soil on top for virtually all soil types.

### 4) MEGAPACKER:

tooth packer roller with larger tube (590mm), which is easier to pull in light soil and ensures better soil consolidation.

# MORE FEATURES AND OPTIONS FOR YOUR BENEFIT



## A SELF-CLEANING FRAME

A special frame design avoids soil from building up on the central beam. When folded in transport position, all residuous soil is moreover removed automatically.



## SAFE ROAD TRANSPORT

The HR 1040 R power harrows are folded hydraulically and locked in transport position. Pivoting twin wheels of large diameter on a standard transport frame ensure easy travel on the road. No braking system is required while transport legislations can even be respected with mid-size tractors. During work you can uncouple the frame to avoid extra weight on the machine. The hydraulic coupling system is very easy to use.



## WORK IN STONY CONDITIONS

V-shaped stone guards can be fitted between two rotors in order to prevent stones from getting jammed.



## WHEEL TRACK ERADICATORS

Optional wheel track eradicators are designed to break up the compacted soil behind the tractor wheels. They are adjustable in depth. Depending on working conditions and the quantity of stones in your plots, you can choose between traction bolt and spring reset safety release systems.



be strong, be **KUHN**



## KUHN PARTS

Designed and manufactured to rival time

KUHN foundries and forge as well as a high-level manufacturing process allow the production of spare parts to defy time. You can truly rely on our know-how and our genuine parts. Farmers benefit from our client support and logistics services via any KUHN PARTS warehouse, which provide quick and reliable repair solutions in cooperation with your nearest authorized KUHN dealer.





## Technical specifications

	HR 6040 R	HR 7040 R	HR 8040 R	
Working width (m/ft)	5.96 / 19'7"	6.96 / 22'10"	8.05 / 26'5"	
Transport width (m/ft)	3.00 / 9'10"			
Transport height (m/ft)	3.25 / 10'8"	3.75 / 12'4"	4.25 / 13'11"	
Max. tractor power (kW/hp)	336 / 460	345 / 480	365 / 500	
Min. tractor power requirement (kW/hp)	131 / 180	161 / 220	175 / 240	
Gearboxes	reinforced central gearbox with oil cooling system; side DUPLEX gearbox			
PTO safety	cam type cut-out clutch on each half-harrow			
PTO speed (min <sup>-1</sup> )	1,000			
Rotor speed (min <sup>-1</sup> )	274 / 349 (after inversion / gearwheels 32-34)			
Number of rotors	20	24	28	
Working depth adjustment	hydraulic			
Levelling bar	◆ (with hydraulic adjustment)			
Side deflectors	◆ (adjustable, with spring safety and double arms)			
Hitch attachment	cat. 3, 4 and 4N with yokes			
Working position	rigid or floating (+/- 2.5°)			
Transport locking position	hydraulic			
Control box	KTS 20: monitoring of gearbox temperature and safety clutch release			
Central front share	◆			
Weight approx. (kg/lbs)	with MAXICRUMBLER roller (Ø 520mm)	4,015 / 8,850	4,350 / 9,590	4,680 / 10,320
	with MAXIPACKER roller (Ø 535mm)	4,515 / 9,950	4,930 / 10,870	5,340 / 11,770
	with MEGAPACKER roller (Ø 590mm)	4,600 / 10,140	5,030 / 11,090	5,465 / 12,050
	with STEELLINER roller (Ø 500mm, 12.5cm row spacing)	4,700 / 10,360	5,130 / 11,310	5,575 / 12,290
Tractor required hydraulic equipment	3x DA (levelling bar, depth adjustment, folding and locking for transport)			

◆ standard equipment ◇ optional equipment - not available

**Optional equipment:** DURAKUHN blades - V-shaped stone guards - anti-wrap collar - track eradicators (non-stop or shear bolt safety) - transport carrying frame.

## KUHN SERVICES\*

Maximize the use and productivity of your kuhn equipment

\*Not all services and equipment are available in every country.

### KUHN sos order

#### EXPRESS SPARE PARTS SERVICE 24/7

You urgently need spare parts? With KUHN sos order benefit from express delivery seven days a week, 365 days a year. Thus, you can minimize machine downtime considerably and increase your work output.

### KUHN protect +

#### THE CHOICE OF PROFESSIONALS!

Benefit from 36 months in complete serenity because of KUHN's protect + warranty. You can concentrate exclusively on your work and the performance of your machine. Because this is what you expect, when investing in high-tech machinery.

### KUHN i tech

#### FOR EVER QUICKER REPAIRS!

An unexpected technical problem always occurs at the wrong time. Your KUHN dealer can support you quickly and efficiently thanks to KUHN i tech. With this 24/7 online service, a quick and exact diagnosis is possible.

### KUHN finance

#### INVEST RATIONALLY!

New machine necessary, financing unsure? Modernize your equipment and develop your farm with KUHN finance, in total safety and according to your needs and demands. We offer custom-made finance solutions, adapted to your requirements.

# WHICH POWER HARROW FOR WHICH FARM?

Series	Max. tractor power kW/hp at 1,000 min <sup>-1</sup>	Recommended usage
HRB 252 - 302 D	103 / 140	mixed farming, from light to medium hard soils   average use
HR 304 - 404 D	139 / 190	intensive arable farming, hard soil conditions and moderately stony
HR 3004 - 3504 - 4004 - 4504 - 5004	184 / 250	intensive arable farming, contractors, machinery rings, difficult soil and stony conditions
HR 6004	265 / 350	
HR 1040 R	336 / 460 - 365 / 500	high output seedbed preparation, contractors, machinery rings; create fine tilth in all soil conditions

## Check out KUHN's extensive offer of tillage tools.



1. Soil looseners - 2. Compact disc harrows - 3. Stubble cultivators - 4. Disc harrows - 5. Strip-till tools - 6. Power tillers

For more information about your nearest KUHN dealer, visit our website [www.kuhn.com](http://www.kuhn.com)

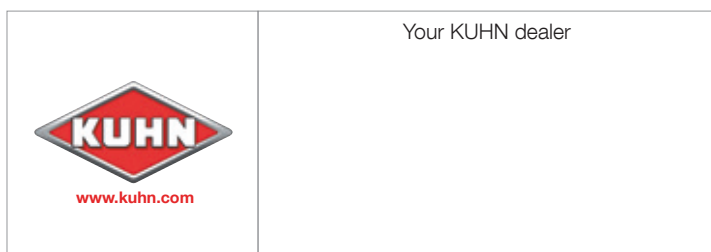
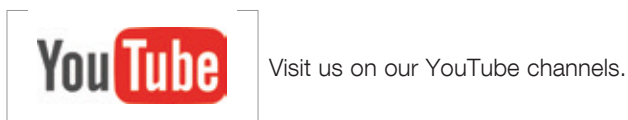

### KUHN SAS

4 Impasse des Fabriques - BP 50060  
F-67706 Saverne CEDEX - FRANCE

### KUHN NORTH AMERICA, INC.

1501 West Seventh Avenue - Brodhead,  
WI 53520 - USA

### KUHN FARM MACHINERY PTY. LTD

313-325 Foleys Road - Deer Park, VIC, 3023 - AUSTRALIA

### KUHN FARM MACHINERY (U.K.) LTD

Stafford Park 7 - GB TELFORD/ SHROPS TF3 3BQ

Information given in this document is only for information purposes and is non-contractual. Our machines are in compliance with regulations in force in the country of delivery. In our literature, and for improved illustration of certain details, some safety devices may not be in operating position. When operating these machines, these devices must be in position in accordance with the requirements indicated in the operator's manuals and assembly manuals. Respect the tractor gross vehicle weight rating, its lift capacity and maximum load per axle and tyres. The tractor front axle load must always comply with the regulations of the country of delivery (In Europe, it must reach minimum 20 % of the tractor net weight). We reserve the right to change any designs, specifications or materials listed without further notice. Machines and equipment in this document can be covered by at least one patent and/or registered design. Trademarks cited in this document may be registered in one or several countries.

Also find KUHN on